

Data Sheet

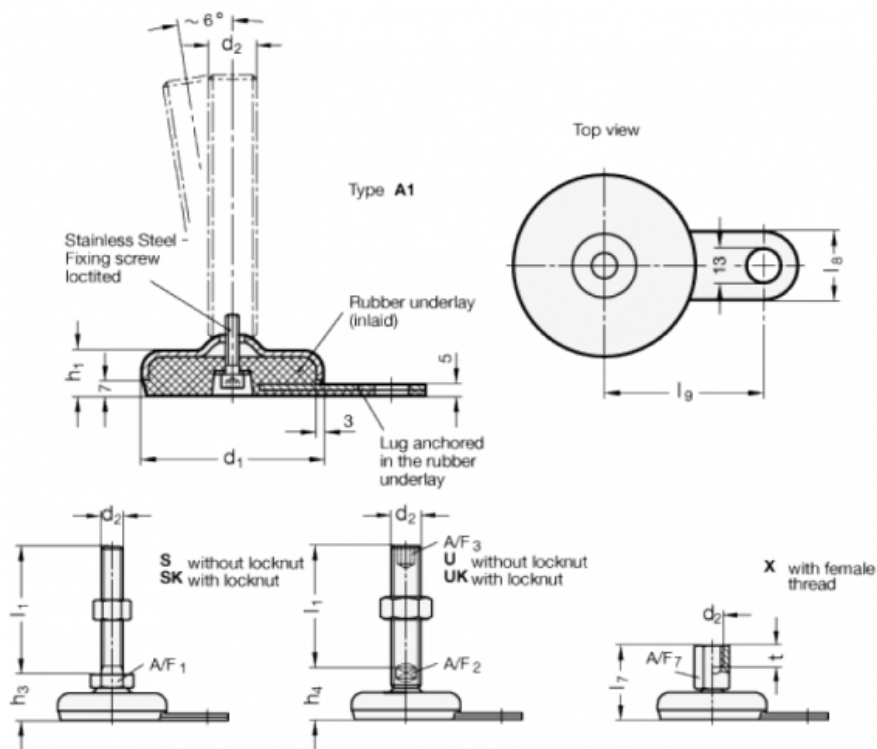

Article number: 203250M1652A1X
Description: E+G levelling foot
GN 32-50-M16-52-A1-X
Note: X With female thread, External hexagon

Measures



A/F7	=	22
d1	=	50
d2	=	M16
h1	=	18
l7	=	52
l8	=	25
l9	=	45
t	=	16